

Assembly Instructions Provincial Model 201

Thank you for your speaker stand purchase.

If you have any difficulties assembling your stand you may contact us via telephone at 716-294-0180 or e.mail us at: sales@speakerstand.net

Replacement parts are also available.

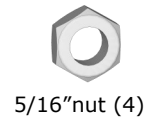
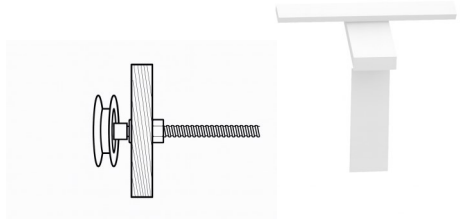
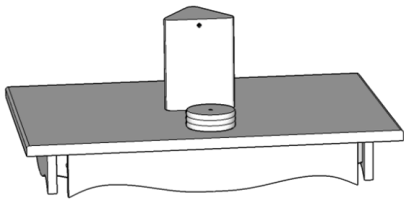
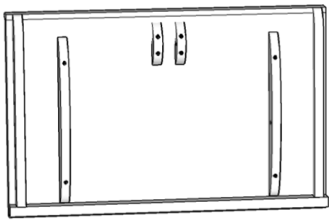
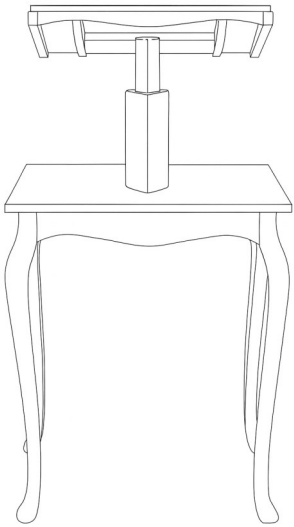

5/16"nut (4)

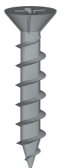

1"philips head screw (4)



Split lock washer (4)

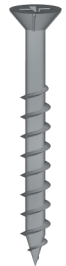

1 1/4"philips head screw (8)

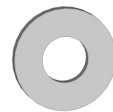

Flat washer (4)

Tools re-

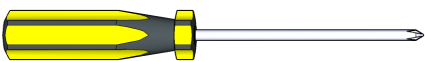

#2 Philips screwdriver

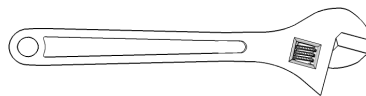

Adjustable wrench

or

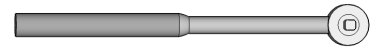

5/16"socket and wrench

or for faster assembly

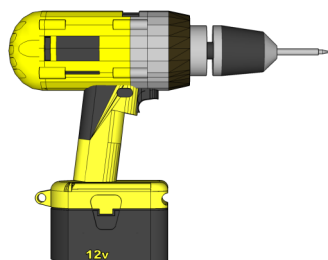

Tip: If you are using a cordless drill that has an adjustable clutch, set it around 5-7 to avoid over tightening the screws.

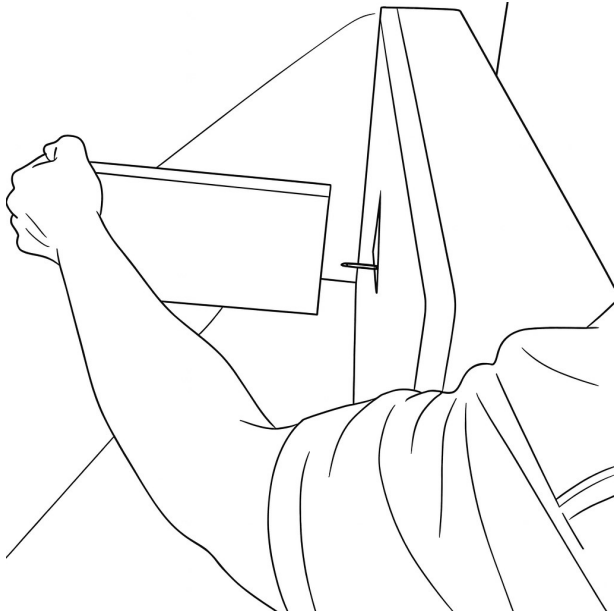

Step 1 Attach height adjustment block to main base. Use the four 2" screws. Please be sure to use existing bores. You may need two people for this procedure.

Step 2: Install raising mechanism with two 1 1/4" screws.

IMPORTANT: Match marks and use existing bores to attach this mechanism. Failure to do so will result in a misalignment and operation of the lectern will suffer. Connect belt to the two pulleys.

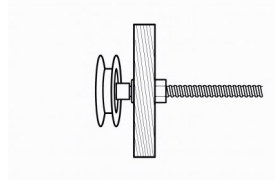
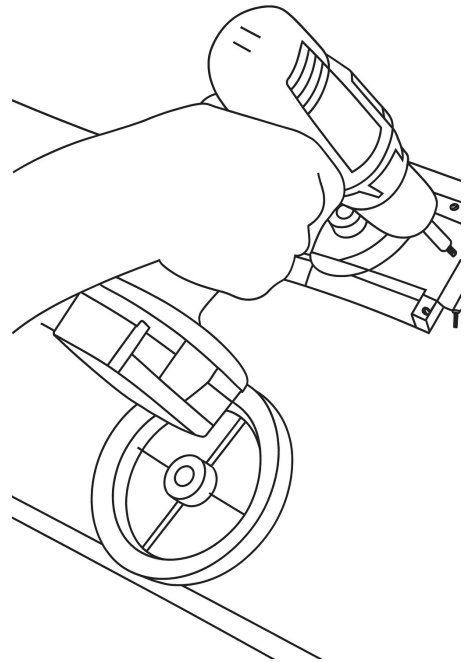

Step 3 Place the base top upside down on a surface that will not scratch the wood. Using two chairs is recommended.

Step 4 Install the four (4) legs onto the base using a flat washer, split lock washer, and nut. Please note that the numbers on the each of the legs should match up with the numbers written on the base top for proper assembly.

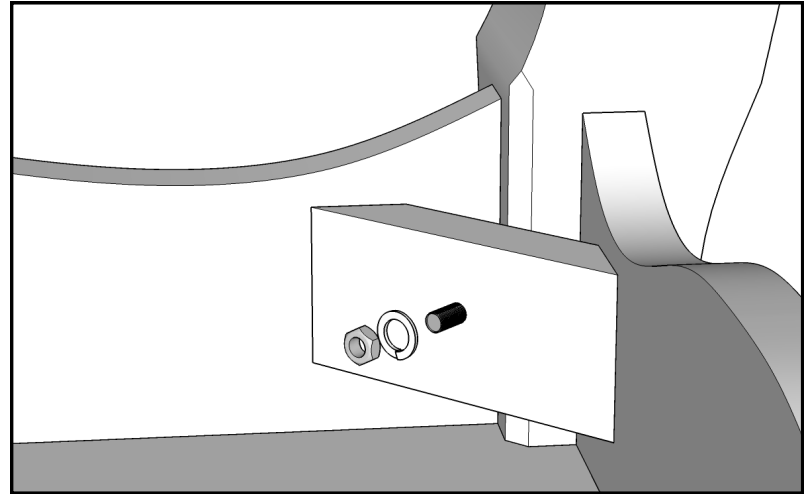

Step 5 Install the bottom cover using the provided four (4)

Step 6: Attach the table to the center column. Remove the screws from the small and large half moon shaped pieces on one side. Slide the pins on the adjustable section into the mounting holes. Reinstall the small and large half moon shape pieces.

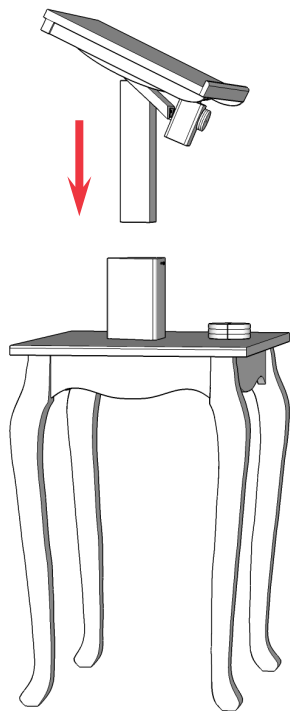
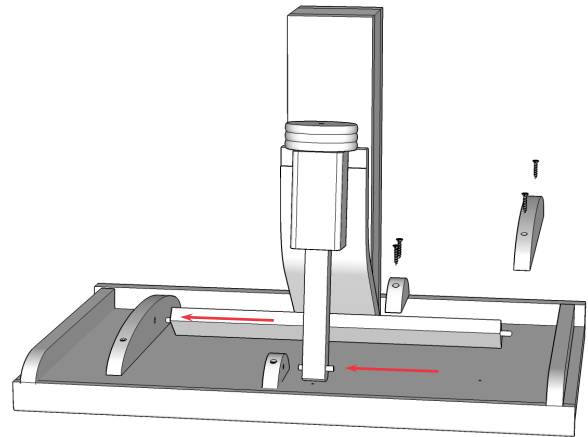

Step 7: Install the adjustable section onto the base. Turn the adjustment knob clockwise to lower it about 1 inch.

If your lectern is electric, use switch to lower the tilting table assembly.

Step 8: Tighten the safety stop screw. This will prevent the adjustable section from extending too far.

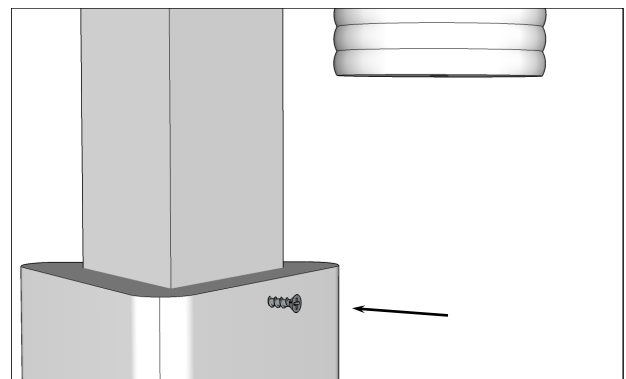

Troubleshooting:**1. After putting everything together, it's difficult to raise the adjuster column with the knob.**

It may be that the raising mechanism is misaligned. Remove pulley with long screw from adjuster column. Reinsert long screw into metal plate. Reattach to base with two screws, but don't use the same bored holes as before. Reattach belt. Check for obstructions in the outer column. Sometimes a piece of felt may have become loose and is hindering movement.

2. We have the electric version. The motor has problems raising the adjuster column.

The problem may be the same as troubleshooting point #1. Also, check the plastic pulley to make the set screws (there are two) are tight against the pole on the motor. The belt may be slipping and needs to be sprayed with belt conditioner.

3. Our furniture arrived with damage to the finish. There's a crack in the wood.

Great care was taken in packing your furniture, but occasionally it arrives damaged. Please take pictures of the damage and email them to sales@speakerstand.net. Some minor scratches can be covered up with a colored marker.

Maintenance:

Long screw should be lubricated from time to time to keep raising mechanism running smooth.

We recommend cleaning your furniture with a product such as Orange-Glo, or a lemon oil, or Murphy's Oil Soap. Furniture polishes such as Pledge can dull the finish over time.